

# CMH/CMV – CARTONING MACHINES

*For various  
bag-in-box  
applications  
and direct  
filling.*

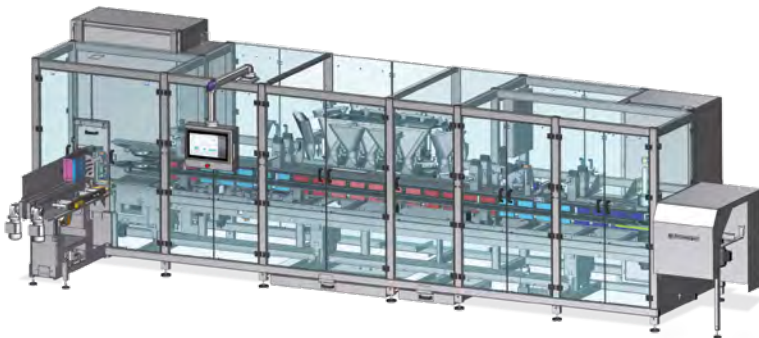

Continuous and  
intermittent solutions  
tailored to your  
product, also with  
product compaction

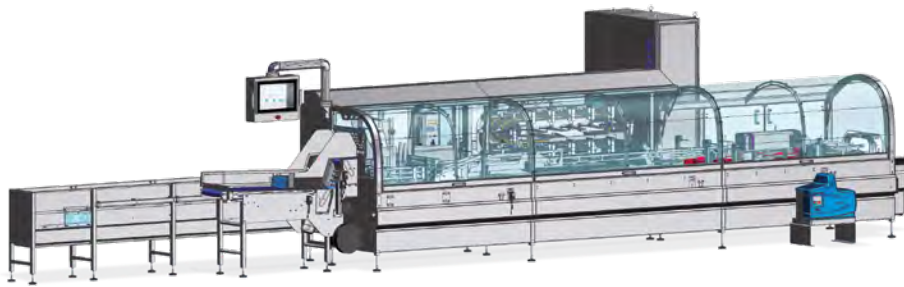

## ROVEMA CARTONING MACHINES

### The highlights.

- Intuitive, easily understandable operation, user interface with graphic support in national language
- Fast, reproducible and tool-free format change, additional options for further simplifications available

 **ROVEMA**

Passion for packaging



# CMH-C – CONTINUOUS MOTION HORIZONTAL CARTONING MACHINE

For bag-in-box applications  
Output range up to 225 folding boxes per minute

## Benefits and advantages of the CMH-C.

- Trouble-free processing of critical folding box material with an air frame erection
- Decentral drives for the main modules of the machine
- Loading module available with top confiner and overfilling detector in conjunction with automatic ejection
- Fast, reproducible and tool-free format change, additional options for further simplifications available
- Intuitive, easily understandable operation, user interface with graphic support in national language

## Hygiene and ergonomics.

In addition to a hygienic design with gull wing doors for easy access and low ergonomic loading height of the blank magazine, the machine offers solidly constructed functional subassemblies and adjustments. Internal components and components in contact with the product are made of stainless steel. Upon request, the frame is also available in stainless steel.

## Easily adapted to product and format.

The format change is tool-free, quick and can be extended with half or fully automatic adjustments. Packing of soft bags and stacks of bags is supported for the optional product conditioner and top confiner. These units also ensure smooth production when difficult products are loaded.

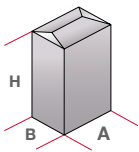

	A (mm) min./max.	B (mm) min./max.	H (mm) min./max.	Output (cartons/min)
CMH-C 7,5"	85/165	30/120	110/300	225
CMH-C 9"	85/210	30/120	110/300	190
CMH-C 12"	105/280	30/120	110/300	140
CMH-C 13,5"	125/315*	30/120	110/300	125

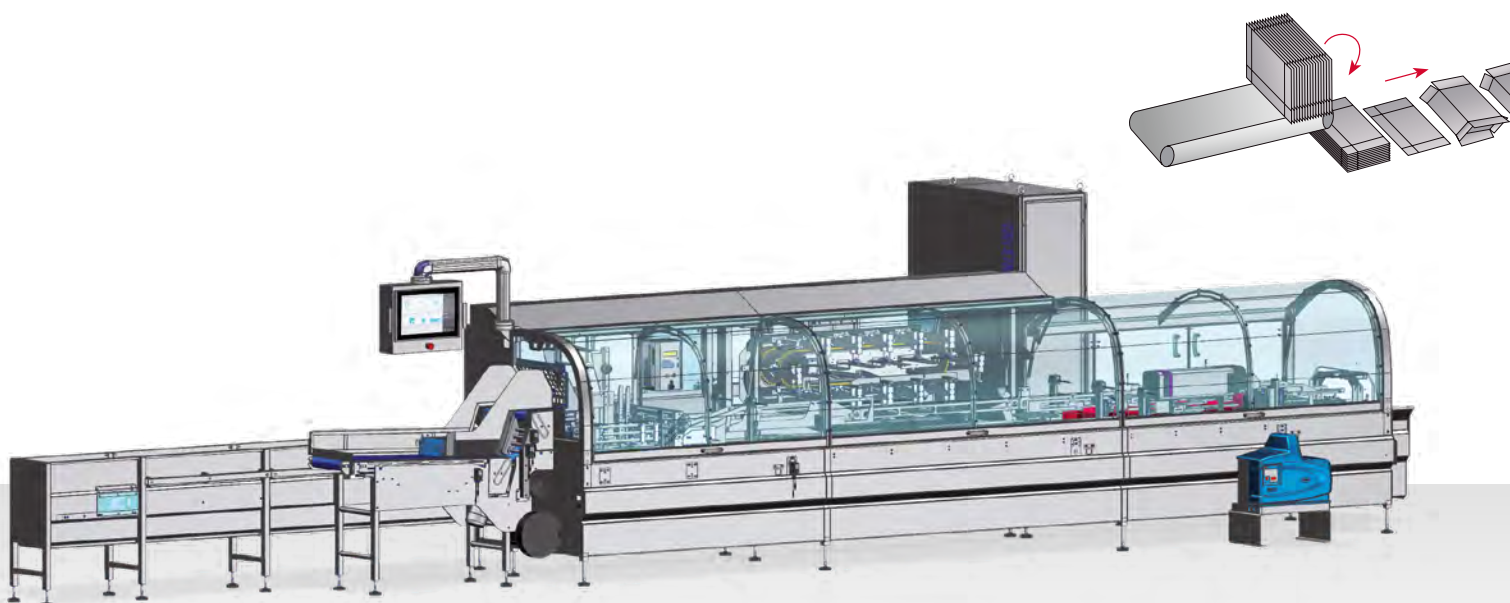

# CMH-I – INTERMITTENT MOTION HORIZONTAL CARTONING MACHINE

Compact construction  
Output range up to 75 folding boxes per minute

## Benefits and advantages of the CMH-I.

- Trouble-free processing of critical folding box material due to forced box erection
- Mirrored installation possible without difficulties
- Decentral drives
- Dual inserts available with upper guides.
- Fast, reproducible and tool-free format change, additional options for further simplifications available
- Intuitive, easily understandable operation, user interface with graphic support in national language
- Hygienic design

## Hygiene, ergonomics and accessibility.

To meet the hygienic design requirements, internal components and components in contact with the product are made of stainless steel. Upon request, the frame is also available in stainless steel. In the CMH-I construction, great attention was paid to the ergonomic loading height of blank magazines and solid construction of the functional relevant components.

The compact design ensures optimized accessibility which is important for fast and easy setup of the machine. With the opening of just one single door, all machine components can be directly reached by the operator.

## Easily adapted to the product and format.

The format change from just one side is tool-free, quick and can be extended with half or fully automatic adjustments. Packing of soft bags and stacks of bags is supported for the optional product conditioner and top confiner. These units also ensure smooth production when difficult products are loaded.

## Box erection.

A special feature of the machine is the box erection, which allows to erect boxes on the left or right. Thus, a mirrored installation of two machines is possible without difficulties. The forced opening of boxes reduces troubles during erection of boxes.

## Insertion and movement profiles.

Dual insertion slots and automatic calculation of movement profiles for all drives ensure optimized slow movements. Thus, the machine operates smoothly and reliably.

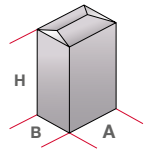

## Size ranges of the CMH-I.

### CMH-I 9"

Box size A (min./max.)	80–210 mm
Box size B (min./max.)	20–120 mm
Box size H (min./max.)	110–300 mm

Special sizes and production capacities on request.

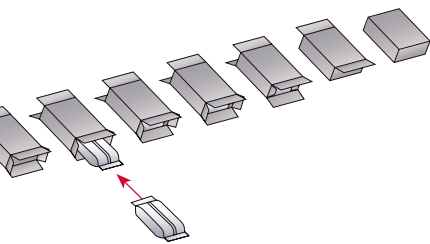

CMH-I

# CMV – VERTICAL CARTONING MACHINE BAG-IN-BOX

Filling degree up to 95% with product compaction  
Output range up to 120 folding boxes per minute

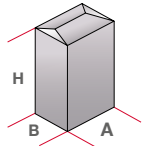

## Benefits and advantages of the CMV.

- Various bag top shapes possible
- Compact and flexible
- Safe and secure box erection by a separately powered rotation picker with forced box erection
- Gentle operation due to oscillating chain movements
- Programmable 3-dimensional format change, 100% reproducible, reduces conversion times
- Intuitive, easily understandable operation, user interface with graphic support in national language
- Additional options for compactable products

## The most compact and flexible cartoning method.

The ROVEMA CMV series can be supplied with one or two integrated Form Fill and Seal machines as a compact, flexible bag-in-box machine, optionally available with direct-filling facilities.

- Bag in folded box
- Bag without folded box
- Product filled directly into the folding box

All this is available from a very compact machine.

## Compact and flexible.

Probably the most compact bag-in-box line. This case, one or two Form Fill and Seal machines are integrated into a cartoning machine, additional conveyors and/or transfer systems are not required. Depending on configuration and application, up to 120 folding boxes per minute can be produced. The bags are transferred vertically directly from the Form Fill and Seal machine into the folding box. The folding boxes are transported through the machine with oscillating movements so that the bag is transferred safely into the box.

## Unique Features.

In addition to the patented box erection and automatic format adjustments, the CMV offers further advantages compared to horizontal cartoning machines. Additional modules in the machine can compact the products to achieve a box filling degree of 95%. Ideal for compactable products such as tea or aerated powders.

## Size ranges of the CMV.

### CMV 160

Box size A (min./max.)	50–160 mm
Box size B (min./max.)	15–100 mm
Box size H (min./max.)	80–320 mm

### CMV 220

Box size A (min./max.)	60–220 mm
Box size B (min./max.)	20–100 mm
Box size H (min./max.)	120–320 mm

Special sizes and production capacities on request.

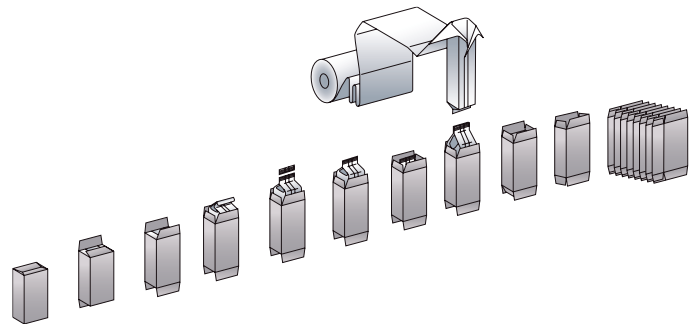

## Bag-in-Box



CMV

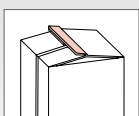

90° folding of the top fin

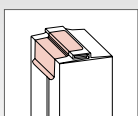

Label as reclosure

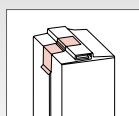

Adhesive tape as reclosure

---

# CMV – VERTICAL CARTONING DIRECT FILLING

---

Output range up to  
200 folding boxes per minute

## Benefits and advantages of the CMV – direct filling.

- Easily accessible, clearly arranged functions and line design.
- Safe and secure box erection by a separately powered rotation picker with forced box erection
- Sturdy welded tubular frame
- Programmable 3-dimensional format change, 100% reproducible, reduces conversion times
- Intuitive, easily understandable operation, user interface with graphic support in national language

The machine can pack up to 200 folding boxes per minute and is designed for the direct packing of free-flowing and dusting products into boxes. The machine's frame is similar to the bag-in-box CMV, but a continuously revolving filling module is located at the center of the machine.

## Clear layout and easy set up.

The machine is designed in a line-design and can be controlled completely from the front. The box erection, box transportation with the different closing modules, as well as the filling module are clearly visible. In addition to the labyrinth folding system that is usually required for direct filling, a tight gluing system can be integrated. Simple format adjustments, a clear line design and an excellent machine control speak for themselves.

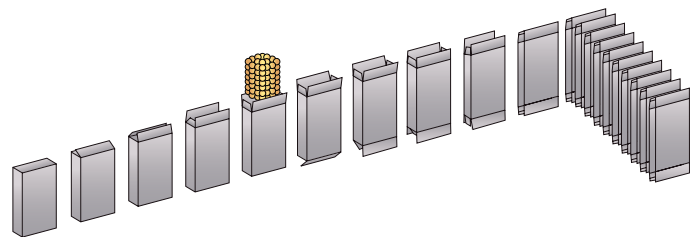

Direct filling

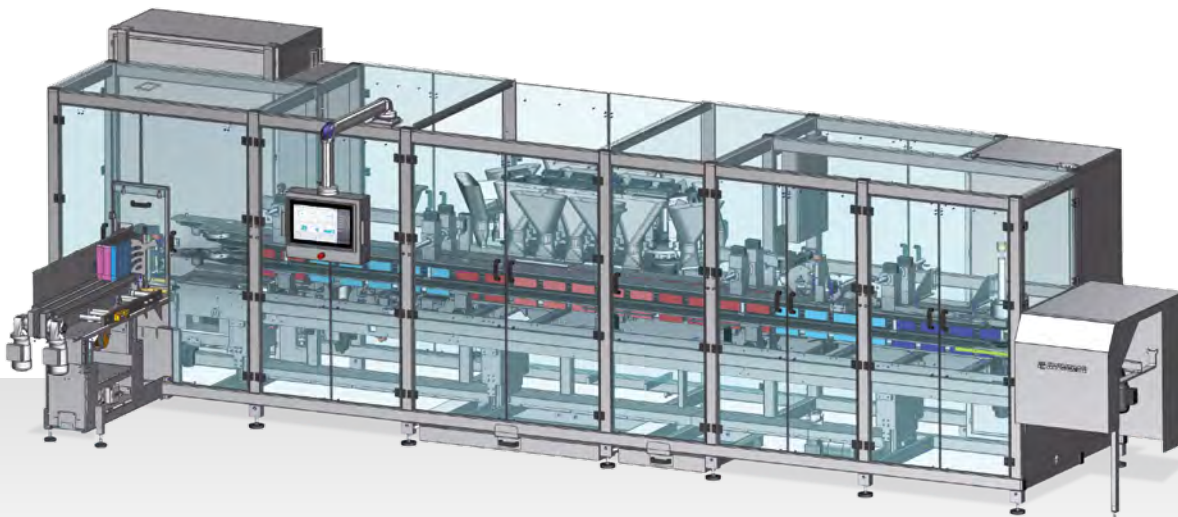

CMV direct filling

# ROVEMA worldwide

Products & Life Cycle Services



Passion for packaging

## Subsidiaries

ROVEMA GmbH  
35463 Fernwald  
info@rovema.de

ROVEMA France SAS  
93360 Neuilly-Plaisance  
info@rovema.fr

ROVEMA Benelux bv  
4902 TT Oosterhout  
sales@rovema.nl

ROVEMA Italia s.r.l.  
20026 Novate Milanese (MI)  
info@rovema-italia.it

ROVEMA Packaging  
Machines Ltd  
Gatehouse Close/Aylesbury  
sales@rovema.co.uk

ROVEMA Spain and Portugal S.L.  
08208 Sabadell/Barcelona  
rovema@rovema.es

ROVEMA Makine San. Ve Tic. A.S.  
34870 Kartal/Istanbul  
info@rovema.com.tr

OOO ROVEMA  
196247 St. Petersburg, Russia  
info@rovema.ru

ROVEMA Polska Sp. z o.o.  
02-672 Warszawa  
rovema@rovema.pl

ROVEMA North America Inc.  
Norcross, GA 30093  
info@rovema-na.com

ROVEMA Latinoamérica S.A.  
Panama City  
rlainfo@rovema.com

ROVEMA Asia Pacific  
Corporation  
Makati City/Philippines  
info@rovema.com.ph

## ROVEMA Affiliates

DL Packaging  
www.dlpack.com

Hassia Packaging Pvt Ltd  
www.hassiaindia.in

inno-tech  
Verpackungsmaschinen GmbH  
www.innotech-gmbh.com